

	Paires		Contrat	par	Entame	= + _	Nord-Sud	Est-Ouest	SIMULTANÉ DU ROY RENÉ											
	NS	EO							Sud	Ouest	Nord	Est								
1																				
2																				
3																				
4																				
5																				
6																				
7																				
8																				
9																				
10																				
11																				
12																				
13																				
14																				
15																				

♠ 2  
♥ V  
♦ ADV10954  
♣ D983

♠ 64  
♥ R9543  
♦ 2  
♣ R10764

♠ D105  
♥ A87  
♦ R763  
♣ V52

♠ ARV9873  
♥ D1062  
♦ 8  
♣ A

	Sud	Ouest	Nord	Est
<b>Entame :</b>			3 <span style="color: orange;">♦</span>	—
<span style="color: orange;">♦</span> 2			4 <span style="color: orange;">♦</span>	—
<b>Par :</b>			—	—
Sud 4 <span style="color: blue;">♠</span> =				

Séance n°5

[www.bridgeplus.com](http://www.bridgeplus.com) - Simultanés Roy René

	Paires		Contrat	par	Entame	= + _	Nord-Sud	Est-Ouest	SIMULTANÉ DU ROY RENÉ											
	NS	EO							Sud	Ouest	Nord	Est								
1																				
2																				
3																				
4																				
5																				
6																				
7																				
8																				
9																				
10																				
11																				
12																				
13																				
14																				
15																				

♠ AD3  
♥ V6  
♦ RV1095  
♣ R105

♠ 10654  
♥ RD83  
♦ —  
♣ V8743

♠ 987  
♥ A102  
♦ D8762  
♣ D2

♠ RV2  
♥ 9754  
♦ A43  
♣ A96

	Sud	Ouest	Nord	Est
<b>Entame :</b>			1 <span style="color: orange;">♦</span>	—
<span style="color: blue;">♠</span> 9			1 <span style="color: red;">♥</span>	—
<b>Par :</b>			3 SA	—
Nord 3SA-1			—	—

Séance n°5

[www.bridgeplus.com](http://www.bridgeplus.com) - Simultanés Roy René

	Paires		Contrat	par	Entame	= + _	Nord-Sud	Est-Ouest	SIMULTANÉ DU ROY RENÉ				
	NS	EO											
1													
2													
3													
4													
5													
6													
7													
8													
9													
10													
11													
12													
13													
14													
15													

♠ D82 ♥ — ♦ 1098732 ♣ 10972		♠ 765 ♥ RV954 ♦ DV ♣ RDV		
♠ AR4 ♥ 1087632 ♦ AR ♣ 65				
♠ V1093 ♥ AD ♦ 654 ♣ A843				
<b>Entame :</b>	<b>Sud</b>	<b>Ouest</b>	<b>Nord</b>	<b>Est</b>
♠ Valet	—	2 SA	—	1 ♥
<b>Par :</b>	—	—	—	4 ♥
Est 4 ♥ -1				
Séance n°5				
www.bridgeplus.com - Simultanés Roy René				

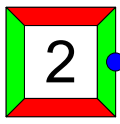
	Paires		Contrat	par	Entame	= + _	Nord-Sud	Est-Ouest	SIMULTANÉ DU ROY RENÉ				
	NS	EO											
1													
2													
3													
4													
5													
6													
7													
8													
9													
10													
11													
12													
13													
14													
15													

♠ 98542 ♥ 9432 ♦ 2 ♣ 972		♠ 6 ♥ AV1076 ♦ D87 ♣ AR43		
♠ RV7 ♥ D8 ♦ RV1065 ♣ 1065				
♠ AD103 ♥ R5 ♦ A943 ♣ DV8				
<b>Entame :</b>	<b>Sud</b>	<b>Ouest</b>	<b>Nord</b>	<b>Est</b>
♠ 4	X	XX	1 ♠	1 ♥
<b>Par :</b>	—	1 SA	—	3 SA
Ouest 3SA +1	—	—	—	
Séance n°5				
www.bridgeplus.com - Simultanés Roy René				

								SIMULTANÉ DU ROY RENÉ									
	Paires		Contrat	par	Entame	= + _	Nord-Sud	Est-Ouest									
	NS	EO															
1																	
2																	
3																	
4																	
5																	
6																	
7																	
8																	
9									<b>Entame :</b> ♦ 5	<b>Sud</b>	<b>Ouest</b>	<b>Nord</b>	<b>Est</b>				
10								1 ♦						X	—	1 SA	
11								—						2 SA	—	—	
12									<b>Par :</b> Est 2SA =								
13																	
14																	
15									Séance n°5								
www.bridgeplus.com - Simultanés Roy René																	

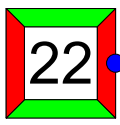
								SIMULTANÉ DU ROY RENÉ									
	Paires		Contrat	par	Entame	= + _	Nord-Sud	Est-Ouest									
	NS	EO															
1																	
2																	
3																	
4																	
5																	
6																	
7																	
8																	
9									<b>Entame :</b> ♠ Dame	<b>Sud</b>	<b>Ouest</b>	<b>Nord</b>	<b>Est</b>				
10								1 ♠						X	—	3 SA	
11								—						—	—	—	
12									<b>Par :</b> Est 3SA =								
13																	
14																	
15									Séance n°5								
www.bridgeplus.com - Simultanés Roy René																	



		Paires		Contrat	par	Entame	= + _	Nord-Sud	Est-Ouest	SIMULTANÉ DU ROY RENÉ				
1	2	NS	EO											
1														
2														
3														
4														
5														
6														
7														
8														
9														
10														
11														
12														
13														
14														
15														

♠ R65  
 ♥ A42  
 ♦ AV432  
 ♣ 75

♠ A32  
 ♥ 973  
 ♦ 75  
 ♣ AV864

♠ 987  
 ♥ RDV10  
 ♦ D109  
 ♣ R32

♠ DV104  
 ♥ 865  
 ♦ R86  
 ♣ D109

5

Entame :	Sud	Ouest	Nord	Est
♥ Roi			1 ♦	—
<b>Par :</b>	1 ♠	—	1 SA	—
Nord 1SA -3	—	—		

Séance n°5

www.bridgeplus.com - Simultanés Roy René

		Paires		Contrat	par	Entame	= + _	Nord-Sud	Est-Ouest	SIMULTANÉ DU ROY RENÉ				
1	2	NS	EO											
1														
2														
3														
4														
5														
6														
7														
8														
9														
10														
11														
12														
13														
14														
15														

♠ AV8765  
 ♥ 5  
 ♦ 54  
 ♣ AR54

♠ 103  
 ♥ AD73  
 ♦ AR732  
 ♣ 92

♠ 2  
 ♥ V9862  
 ♦ V98  
 ♣ DV108

♠ RD94  
 ♥ R104  
 ♦ D106  
 ♣ 763

25

Entame :	Sud	Ouest	Nord	Est
♣ Dame			1 ♠	—
<b>Par :</b>	3 ♠	—	4 ♠	—
Nord 4♠ =	—	—		

Séance n°5

www.bridgeplus.com - Simultanés Roy René

	Paires		Contrat	par	Entame	= + _	Nord-Sud	Est-Ouest
	NS	EO						
1								
2								
3								
4								
5								
6								
7								
8								
9								
10								
11								
12								
13								
14								
15								

## SIMULTANÉ DU ROY RENÉ

♠ A73  
♥ 54  
♦ D1072  
♣ V1098

♠ 54  
♥ D109732  
♦ 65  
♣ A76

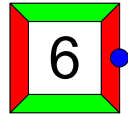

♠ RDV109  
♥ AR6  
♦ R43  
♣ R5

♠ 862  
♥ V8  
♦ AV98  
♣ D432

	Entame :	Sud	Ouest	Nord	Est
	9	♣ Valet			
10	<b>Par :</b>	—	1 SA	—	3 SA
11	<b>Ouest 4 ♥ =</b>	—	4 ♥	—	—
12		—			
13	Séance n°5				

www.bridgeplus.com - Simultanés Roy René

	Paires		Contrat	par	Entame	= + _	Nord-Sud	Est-Ouest
	NS	EO						
1								
2								
3								
4								
5								
6								
7								
8								
9								
10								
11								
12								
13								
14								
15								

## SIMULTANÉ DU ROY RENÉ

♠ R952  
♥ RD753  
♦ AV9  
♣ 4

♠ A3  
♥ V98  
♦ RD4  
♣ AV1053



♠ D84  
♥ A6  
♦ 10752  
♣ R972

♠ V1076  
♥ 1042  
♦ 863  
♣ D86

	Entame :	Sud	Ouest	Nord	Est
	9	♥ 5			
10	<b>Par :</b>	—	1 SA	2 ♣	3 SA
11	<b>Ouest 3SA =</b>	—	—	—	
12		—			
13	Séance n°5				

www.bridgeplus.com - Simultanés Roy René

		Paires		Contrat	par	Entame	= + _	Nord-Sud	Est-Ouest	SIMULTANÉ DU ROY RENÉ			
1	2	NS	EO										
1													
2													
3													
4													
5													
6													
7													
8													
9													
10													
11													
12													
13													
14													
15													

♠ 5432  
♥ D86543  
♦ D  
♣ 106

♠ ARD97  
♥ ARV9  
♦ 87  
♣ D3

♠ V8  
♥ 102  
♦ ARV9432  
♣ 72

♠ 106  
♥ 7  
♦ 1065  
♣ ARV9854

7

Sud	Ouest	Nord	Est
3 ♣	X	—	5 ♦
—	—	—	—

**Entame :**  
♣ As

**Par :**  
Est 5 ♦ -1

Séance n°5

www.bridgeplus.com - Simultanés Roy René

		Paires		Contrat	par	Entame	= + _	Nord-Sud	Est-Ouest	SIMULTANÉ DU ROY RENÉ			
1	2	NS	EO										
1													
2													
3													
4													
5													
6													
7													
8													
9													
10													
11													
12													
13													
14													
15													

♠ AR875  
♥ DV7  
♦ A6  
♣ 653

♠ DV  
♥ 10932  
♦ DV108  
♣ 1087

♠ 102  
♥ AR4  
♦ 5432  
♣ RDV9

♠ 9643  
♥ 865  
♦ R97  
♣ A42

27

Sud	Ouest	Nord	Est
—	—	1 ♠	—
2 ♠	—	—	—

**Entame :**  
♣ Roi

**Par :**  
Nord 2 ♠ +1

Séance n°5

www.bridgeplus.com - Simultanés Roy René

								SIMULTANÉ DU ROY RENÉ					
1	Paires		Contrat	par	Entame	= + _	Nord-Sud	Est-Ouest					
	NS	EO											
2													
3													
4													
5													
6													
7													
8													
9									<b>Entame :</b>	<b>Sud</b>	<b>Ouest</b>	<b>Nord</b>	<b>Est</b>
10									♥ Valet		—	—	—
11									<b>Par :</b>	<b>1</b> ♠	—	<b>1 SA</b>	—
12									Sud 2 ♠ -1	<b>2</b> ♣	—	<b>2</b> ♠	—
13										—	—		
14									Séance n°5				
15									www.bridgeplus.com - Simultanés Roy René				

♠ V7  
 ♥ AD76  
 ♦ D543  
 ♣ V63

♠ D 1042  
 ♥ V 1094  
 ♦ A98  
 ♣ R7

♠ 83  
 ♥ 832  
 ♦ R 1072  
 ♣ A 1082

♠ AR965  
 ♥ R5  
 ♦ V6  
 ♣ D954

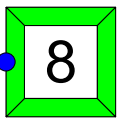

Sud	Ouest	Nord	Est
	—	—	—
<b>1</b> ♠	—	<b>1 SA</b>	—
<b>2</b> ♣	—	<b>2</b> ♠	—
—	—		

								SIMULTANÉ DU ROY RENÉ					
1	Paires		Contrat	par	Entame	= + _	Nord-Sud	Est-Ouest					
	NS	EO											
2													
3													
4													
5													
6													
7													
8													
9									<b>Entame :</b>	<b>Sud</b>	<b>Ouest</b>	<b>Nord</b>	<b>Est</b>
10									♠ Dame		—	—	<b>1 SA</b>
11									<b>Par :</b>	<b>—</b>	<b>2 SA</b>	—	—
12									Est 2SA =	—			
13									Séance n°5				
14									www.bridgeplus.com - Simultanés Roy René				
15													

♠ 82  
 ♥ D 1098  
 ♦ 1072  
 ♣ A973

♠ 65  
 ♥ V32  
 ♦ AR843  
 ♣ 852

♠ AR43  
 ♥ A65  
 ♦ 65  
 ♣ RV64

♠ DV 1097  
 ♥ R74  
 ♦ DV9  
 ♣ D 10

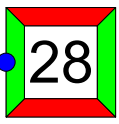

Sud	Ouest	Nord	Est
	—	—	<b>1 SA</b>
—	<b>2 SA</b>	—	—
—			



		Paires		Contrat	par	Entame	= + _	Nord-Sud	Est-Ouest	SIMULTANÉ DU ROY RENÉ			
1	2	NS	EO										
1													
2													
3													
4													
5													
6													
7													
8													
9													
10													
11													
12													
13													
14													
15													

♠ A 1062  
♥ V  
♦ RD95  
♣ DV82

♠ RDV  
♥ R83  
♦ V104  
♣ R1043

♠ 987  
♥ AD4  
♦ A832  
♣ A65

♠ 543  
♥ 1097652  
♦ 76  
♣ 97

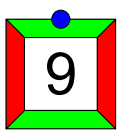

Sud	Ouest	Nord	Est
		1 ♦	—
—	1 SA	—	3 SA
—	—	—	—

**Entame :**  
♣ Dame

**Par :**  
Ouest 3SA =

Séance n°5

www.bridgeplus.com - Simultanés Roy René

		Paires		Contrat	par	Entame	= + _	Nord-Sud	Est-Ouest	SIMULTANÉ DU ROY RENÉ			
1	2	NS	EO										
1													
2													
3													
4													
5													
6													
7													
8													
9													
10													
11													
12													
13													
14													
15													

♠ R964  
♥ R93  
♦ 532  
♣ RD3

♠ ADV72  
♥ 72  
♦ RV984  
♣ 7

♠ 1085  
♥ DV6  
♦ D107  
♣ V1042

♠ 3  
♥ A10854  
♦ A6  
♣ A9865



Sud	Ouest	Nord	Est
		—	—
1 ♥	1 ♠	X	2 ♠
3 ♣	3 ♦	4 ♥	—
—	—	—	—

**Entame :**  
♣ 7

**Par :**  
Sud 4♥ +1

Séance n°5

www.bridgeplus.com - Simultanés Roy René

								SIMULTANÉ DU ROY RENÉ					
Paires		Contrat	par	Entame	= + _	Nord-Sud	Est-Ouest						
NS	EO												
1													
2													
3													
4													
5													
6													
7													
8													
9								<b>Entame :</b> ♠ 2 <b>Par :</b> Ouest 4♥ =	Sud	Ouest	Nord	Est	
10									X	1♥	1♠	1♣	
11									2♠	4♥	—	2♥	
12									—	—	—	—	
13								Séance n°5					
14													
15													

								SIMULTANÉ DU ROY RENÉ					
Paires		Contrat	par	Entame	= + _	Nord-Sud	Est-Ouest						
NS	EO												
1													
2													
3													
4													
5													
6													
7													
8													
9								<b>Entame :</b> ♣ Roi <b>Par :</b> Est 4♥ =	Sud	Ouest	Nord	Est	
10									—	2♣	—	1 SA	
11									—	4♥	—	2♥	
12									—	—	—	—	
13								Séance n°5					
14													
15													

	Paires		Contrat	par	Entame	= + _	Nord-Sud	Est-Ouest	SIMULTANÉ DU ROY RENÉ					
	NS	EO												
1														
2														
3														
4														
5														
6														
7														
8														
9														
10														
11														
12														
13														
14														
15														

♠ V6  
♥ A 1075  
♦ 93  
♣ RD932

♠ ARD5  
♥ DV3  
♦ RD  
♣ AV107

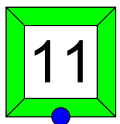

♠ 10942  
♥ R96  
♦ A108742  
♣ —

♠ 873  
♥ 842  
♦ V65  
♣ 8654

<b>Entame :</b> ♣ Roi	<b>Sud</b>	<b>Ouest</b>	<b>Nord</b>	<b>Est</b>
	—	2 ♣	—	2 ♦
	—	2 SA	—	3 ♣
	—	3 ♠	—	4 ♥
	—	5 ♣	—	5 ♦
<b>Par :</b> Ouest 6 ♠ =	—	5 ♠	—	6 ♠
	—	—	—	—

Séance n°5

www.bridgeplus.com - Simultanés Roy René

	Paires		Contrat	par	Entame	= + _	Nord-Sud	Est-Ouest	SIMULTANÉ DU ROY RENÉ					
	NS	EO												
1														
2														
3														
4														
5														
6														
7														
8														
9														
10														
11														
12														
13														
14														
15														

♠ 98432  
♥ 932  
♦ RV2  
♣ R3

♠ R5  
♥ ADV1065  
♦ D3  
♣ V52

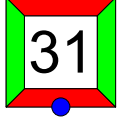

♠ ADV6  
♥ R74  
♦ 765  
♣ 974

♠ 107  
♥ 8  
♦ A10984  
♣ AD1086

<b>Entame :</b> ♣ Roi	<b>Sud</b>	<b>Ouest</b>	<b>Nord</b>	<b>Est</b>
	—	1 ♥	—	2 ♥
	2 SA	3 ♥	—	—
<b>Par :</b> Ouest 3 ♥ -1	—	—	—	—
	—	—	—	—

Séance n°5

www.bridgeplus.com - Simultanés Roy René

	Paires		Contrat	par	Entame	= + _	Nord-Sud	Est-Ouest	SIMULTANÉ DU ROY RENÉ					
	NS	EO							Sud	Ouest	Nord	Est		
1														
2														
3														
4														
5														
6														
7														
8														
9														
10														
11														
12														
13														
14														
15														

♠ ARD985  
♥ 743  
♦ 652  
♣ 4

♠ 6  
♥ AR5  
♦ A1087  
♣ R6532

♠ V1043  
♥ 862  
♦ 43  
♣ A987

♠ 72  
♥ DV109  
♦ RDV9  
♣ DV10

<b>Entame :</b>			
♠ As			
<b>Par :</b>			
Ouest 3♣ =			

Sud	Ouest	Nord	Est
	1 ♣	2 ♠	—
—	X	—	3 ♣
—	—	—	—

Séance n°5

www.bridgeplus.com - Simultanés Roy René

	Paires		Contrat	par	Entame	= + _	Nord-Sud	Est-Ouest	SIMULTANÉ DU ROY RENÉ					
	NS	EO							Sud	Ouest	Nord	Est		
1														
2														
3														
4														
5														
6														
7														
8														
9														
10														
11														
12														
13														
14														
15														

♠ ARV98762  
♥ 5  
♦ 87  
♣ D9

♠ 54  
♥ ARD96  
♦ R43  
♣ 875

♠ 3  
♥ V42  
♦ AD65  
♣ AV643

♠ D10  
♥ 10873  
♦ V1092  
♣ R102

<b>Entame :</b>			
♥ 2			
<b>Par :</b>			
Nord 4♠ x -1			

Sud	Ouest	Nord	Est
	1 ♥	4 ♠	X
—	—	—	—

Séance n°5

www.bridgeplus.com - Simultanés Roy René

		Paires		Contrat	par	Entame	= + _	Nord-Sud	Est-Ouest	SIMULTANÉ DU ROY RENÉ						
1	2	NS	EO							3	4	5	6	7	8	9
										♠ RDV4 ♥ RD65 ♦ 103 ♣ DV5 ♠ 932 ♥ AV72 ♦ 82 ♣ A984 ♠ A 10865 ♥ 43 ♦ ARV7 ♣ 76						♠ 7 ♥ 1098 ♦ D9654 ♣ R1032
										<b>Entame :</b>	<b>Sud</b>	<b>Ouest</b>	<b>Nord</b>	<b>Est</b>		
										♠ 2			1 ♣	—		
										<b>Par :</b>	1 ♠	—	2 ♠	—		
										Sud 4 ♠ =	4 ♠	—	—	—		
										Séance n°5						
										www.bridgeplus.com - Simultanés Roy René						

		Paires		Contrat	par	Entame	= + _	Nord-Sud	Est-Ouest	SIMULTANÉ DU ROY RENÉ						
1	2	NS	EO							3	4	5	6	7	8	9
										♠ D8 ♥ RD 10932 ♦ R2 ♣ A54 ♠ AR10754 ♥ AV4 ♦ 75 ♣ V9 ♠ V6 ♥ 865 ♦ ADV 108 ♣ R87						♠ 932 ♥ 7 ♦ 9643 ♣ D10632
										<b>Entame :</b>	<b>Sud</b>	<b>Ouest</b>	<b>Nord</b>	<b>Est</b>		
										♠ 2			1 ♥	—		
										<b>Par :</b>	2 ♦	2 ♠	3 ♥	—		
										Nord 4 ♥ =	4 ♥	—	—	—		
										Séance n°5						
										www.bridgeplus.com - Simultanés Roy René						

	Paires		Contrat	par	Entame	= + _	Nord-Sud	Est-Ouest	SIMULTANÉ DU ROY RENÉ							
	NS	EO														
1																
2																
3																
4																
5																
6																
7																
8																
9																
10																
11																
12																
13																
14																
15																

<p>♠ RDV 10 ♥ A9875 ♦ R742 ♣ —</p> <p>♠ 6542 ♥ V6 ♦ DV 109 ♣ V87</p>		<p>♠ 3 ♥ D432 ♦ 53 ♣ R65432</p> <p>♠ A987 ♥ R 10 ♦ A86 ♣ AD109</p>																																			
<p><b>Entame :</b> ♦ Dame</p> <p><b>Par :</b> Sud 6♠ =</p>	<table border="1"> <thead> <tr> <th></th> <th>Sud</th> <th>Ouest</th> <th>Nord</th> <th>Est</th> </tr> </thead> <tbody> <tr><td>1</td><td>SA</td><td>—</td><td>2♣</td><td>—</td></tr> <tr><td>2</td><td>♠</td><td>—</td><td>4♣</td><td>—</td></tr> <tr><td>4</td><td>♦</td><td>—</td><td>4♥</td><td>—</td></tr> <tr><td>4</td><td>SA</td><td>—</td><td>5♠</td><td>—</td></tr> <tr><td>5</td><td>SA</td><td>—</td><td>6♦</td><td>—</td></tr> <tr><td>6</td><td>♠</td><td>—</td><td>—</td><td>—</td></tr> </tbody> </table>		Sud	Ouest	Nord	Est	1	SA	—	2♣	—	2	♠	—	4♣	—	4	♦	—	4♥	—	4	SA	—	5♠	—	5	SA	—	6♦	—	6	♠	—	—	—	
	Sud	Ouest	Nord	Est																																	
1	SA	—	2♣	—																																	
2	♠	—	4♣	—																																	
4	♦	—	4♥	—																																	
4	SA	—	5♠	—																																	
5	SA	—	6♦	—																																	
6	♠	—	—	—																																	
<p>Séance n°5</p>																																					
<p>www.bridgeplus.com - Simultanés Roy René</p>																																					

	Paires		Contrat	par	Entame	= + _	Nord-Sud	Est-Ouest	SIMULTANÉ DU ROY RENÉ							
	NS	EO														
1																
2																
3																
4																
5																
6																
7																
8																
9																
10																
11																
12																
13																
14																
15																

<p>♠ R 10 ♥ RV8 ♦ D765 ♣ 9854</p> <p>♠ 432 ♥ 432 ♦ AV32 ♣ RV2</p>		<p>♠ 65 ♥ A976 ♦ R1094 ♣ D63</p> <p>♠ ADV987 ♥ D 105 ♦ 8 ♣ A 107</p>															
<p><b>Entame :</b> ♥ 2</p> <p><b>Par :</b> Sud 2♠ +1</p>	<table border="1"> <thead> <tr> <th></th> <th>Sud</th> <th>Ouest</th> <th>Nord</th> <th>Est</th> </tr> </thead> <tbody> <tr><td>1</td><td>♠</td><td>—</td><td>1 SA</td><td>—</td></tr> <tr><td>2</td><td>♠</td><td>—</td><td>—</td><td>—</td></tr> </tbody> </table>		Sud	Ouest	Nord	Est	1	♠	—	1 SA	—	2	♠	—	—	—	
	Sud	Ouest	Nord	Est													
1	♠	—	1 SA	—													
2	♠	—	—	—													
<p>Séance n°5</p>																	
<p>www.bridgeplus.com - Simultanés Roy René</p>																	

	Paires		Contrat	par	Entame	= + _	Nord-Sud	Est-Ouest	SIMULTANÉ DU ROY RENÉ					
	NS	EO							Sud	Ouest	Nord	Est		
1														
2														
3														
4														
5														
6														
7														
8														
9														
10														
11														
12														
13														
14														
15														

♠ 5  
♥ A 10764  
♦ RV98  
♣ 865

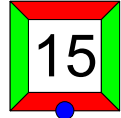

♠ 32  
♥ 32  
♦ 432  
♣ RV9432

♠ RV976  
♥ DV8  
♦ 7  
♣ AD107

♠ AD1084  
♥ R95  
♦ AD1065  
♣ —

<b>Entame :</b> ♣ 5	<b>Sud</b> <b>Ouest</b> <b>Nord</b> <b>Est</b>
<b>Par :</b> Sud 1 ♠ -2	1 ♠      —      —      —

Séance n°5

www.bridgeplus.com - Simultanés Roy René

	Paires		Contrat	par	Entame	= + _	Nord-Sud	Est-Ouest	SIMULTANÉ DU ROY RENÉ					
	NS	EO							Sud	Ouest	Nord	Est		
1														
2														
3														
4														
5														
6														
7														
8														
9														
10														
11														
12														
13														
14														
15														

♠ D65  
♥ RD  
♦ AV1043  
♣ D76

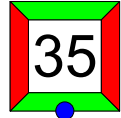

♠ 843  
♥ 109873  
♦ 76  
♣ R 105

♠ ARV9  
♥ A6  
♦ 852  
♣ A943

♠ 1072  
♥ V542  
♦ RD9  
♣ V82

<b>Entame :</b> ♥ 10	<b>Sud</b> <b>Ouest</b> <b>Nord</b> <b>Est</b>
<b>Par :</b> Ouest 3SA +2	—    1 ♦    —    1 ♠
	—    1 SA    —    3 SA
	—    —    —    —

Séance n°5

www.bridgeplus.com - Simultanés Roy René

		Paires		Contrat	par	Entame	= + _	Nord-Sud	Est-Ouest	SIMULTANÉ DU ROY RENÉ			
1	2	NS	EO										
1													
2													
3													
4													
5													
6													
7													
8													
9													
10													
11													
12													
13													
14													
15													

♠ D54  
♥ R872  
♦ RD2  
♣ RDV

♠ RV109  
♥ A6  
♦ 7543  
♣ 984

♠ 87  
♥ 543  
♦ AV10986  
♣ A6

♠ A632  
♥ DV109  
♦ —  
♣ 107532

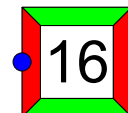

<b>Entame :</b>	<b>Sud</b>	<b>Ouest</b>	<b>Nord</b>	<b>Est</b>
♥ Dame		—	1 SA	—
<b>Par :</b>	3 SA	—	—	—
Nord 3SA -1				

Séance n°5

www.bridgeplus.com - Simultanés Roy René

		Paires		Contrat	par	Entame	= + _	Nord-Sud	Est-Ouest	SIMULTANÉ DU ROY RENÉ			
1	2	NS	EO										
1													
2													
3													
4													
5													
6													
7													
8													
9													
10													
11													
12													
13													
14													
15													

♠ 62  
♥ A93  
♦ 862  
♣ D10982

♠ DV8  
♥ RV10  
♦ AR5  
♣ A743

♠ 43  
♥ D875  
♦ DV109  
♣ RV5

♠ AR10975  
♥ 642  
♦ 743  
♣ 6

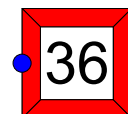

<b>Entame :</b>	<b>Sud</b>	<b>Ouest</b>	<b>Nord</b>	<b>Est</b>
♦ Dame		1 ♣	—	1 ♠
<b>Par :</b>	—	2 SA	—	4 ♠
Est 4 ♠ +1	—	—	—	—

Séance n°5

www.bridgeplus.com - Simultanés Roy René



	Paires		Contrat	par	Entame	= + _	Nord-Sud	Est-Ouest	SIMULTANÉ DU ROY RENÉ				
	NS	EO											
1													
2													
3													
4													
5													
6													
7													
8													
9									<b>Entame :</b> ♦ Roi	Sud	Ouest	Nord	Est
10								5 ♣		—	4 ♣	—	
11									<b>Par :</b> Nord 5 ♣ -1				
12													
13									Séance n°5				
14													
15													

♠ 7  
♥ D7  
♦ 54  
♣ DV1098754

♠ V1032  
♥ 932  
♦ A982  
♣ R2

17

♠ 984  
♥ A104  
♦ RD10763  
♣ 3

♠ ARD65  
♥ RV865  
♦ V  
♣ A6

www.bridgeplus.com - Simultanés Roy René

	Paires		Contrat	par	Entame	= + _	Nord-Sud	Est-Ouest	SIMULTANÉ DU ROY RENÉ				
	NS	EO											
1													
2													
3													
4													
5													
6													
7													
8													
9									<b>Entame :</b> ♦ 3	Sud	Ouest	Nord	Est
10								X		—	1 ♦	2 ♣	
11								<b>Par :</b> Nord 3 ♦ +1	3 ♦	—	—	—	
12													
13									Séance n°5				
14													
15													

♠ V1083  
♥ AD  
♦ AV965  
♣ R9

♠ A754  
♥ V10963  
♦ D8  
♣ 106

37

♠ R62  
♥ 72  
♦ 43  
♣ ADV853

♠ D9  
♥ R854  
♦ R1072  
♣ 742

www.bridgeplus.com - Simultanés Roy René

	Paires		Contrat	par	Entame	= + _	Nord-Sud	Est-Ouest	SIMULTANÉ DU ROY RENÉ																						
	NS	EO																													
1																															
2																															
3																															
4																															
5																															
6																															
7																															
8																															
9									<b>Entame :</b> ♦ Roi	<b>Par :</b> Est 4♥ =	<table border="1"> <thead> <tr><th>Sud</th><th>Ouest</th><th>Nord</th><th>Est</th></tr> </thead> <tbody> <tr><td></td><td></td><td></td><td>1♥</td></tr> <tr><td>2♦</td><td>2♥</td><td>3♦</td><td>X</td></tr> <tr><td>—</td><td>4♥</td><td>—</td><td>—</td></tr> <tr><td>—</td><td>—</td><td>—</td><td>—</td></tr> </tbody> </table>	Sud	Ouest	Nord	Est				1♥	2♦	2♥	3♦	X	—	4♥	—	—	—	—	—	—
Sud	Ouest	Nord	Est																												
			1♥																												
2♦	2♥	3♦	X																												
—	4♥	—	—																												
—	—	—	—																												
10																															
11																															
12																															
13																															
14																															
15																															
									Séance n°5																						
www.bridgeplus.com - Simultanés Roy René																															







	Paires		Contrat	par	Entame	= + _	Nord-Sud	Est-Ouest	SIMULTANÉ DU ROY RENÉ																						
	NS	EO																													
1																															
2																															
3																															
4																															
5																															
6																															
7																															
8																															
9									<b>Entame :</b> ♥ 7	<b>Par :</b> Est 3♠ =	<table border="1"> <thead> <tr><th>Sud</th><th>Ouest</th><th>Nord</th><th>Est</th></tr> </thead> <tbody> <tr><td></td><td></td><td></td><td>1♠</td></tr> <tr><td>—</td><td>1SA</td><td>2♥</td><td>X</td></tr> <tr><td>—</td><td>2♠</td><td>—</td><td>3♠</td></tr> <tr><td>—</td><td>—</td><td>—</td><td>—</td></tr> </tbody> </table>	Sud	Ouest	Nord	Est				1♠	—	1SA	2♥	X	—	2♠	—	3♠	—	—	—	—
Sud	Ouest	Nord	Est																												
			1♠																												
—	1SA	2♥	X																												
—	2♠	—	3♠																												
—	—	—	—																												
10																															
11																															
12																															
13																															
14																															
15																															
									Séance n°5																						
www.bridgeplus.com - Simultanés Roy René																															



	Paires		Contrat	par	Entame	= + _	Nord-Sud	Est-Ouest	SIMULTANÉ DU ROY RENÉ					
	NS	EO												
1														
2														
3														
4														
5														
6														
7														
8														
9									<b>Entame :</b> ♣ Roi	<b>Par :</b> Sud 4♠ -1	<b>Sud</b>	<b>Ouest</b>	<b>Nord</b>	<b>Est</b>
10								1 SA			—	2 ♣	—	
11										2 ♠	—	4 ♠	—	
12										—	—			
13								Séance n°5						
14														
15														

www.bridgeplus.com - Simultanés Roy René

	Paires		Contrat	par	Entame	= + _	Nord-Sud	Est-Ouest	SIMULTANÉ DU ROY RENÉ					
	NS	EO												
1														
2														
3														
4														
5														
6														
7														
8														
9									<b>Entame :</b> ♥ 3	<b>Par :</b> Sud 1SA +3	<b>Sud</b>	<b>Ouest</b>	<b>Nord</b>	<b>Est</b>
10								—			—	1 ♣	1 ♥	
11										1 SA	—	—	—	
12														
13								Séance n°5						
14														
15														

www.bridgeplus.com - Simultanés Roy René

	Paires		Contrat	par	Entame	= + _	Nord-Sud	Est-Ouest	SIMULTANÉ DU ROY RENÉ						
	NS	EO													
1															
2															
3															
4															
5															
6															
7															
8															
9									<b>Entame :</b>	<b>Sud</b>	<b>Ouest</b>	<b>Nord</b>	<b>Est</b>		
10								 2			1 	—	1 		
11								<b>Par :</b>							
12									Est 6SA =		4 	—	4 SA		
13								Séance n°5		5 	—	5 			
14										5 SA	—	6 SA			
15										—	—	—			
													www.bridgeplus.com - Simultanés Roy René		

	Paires		Contrat	par	Entame	= + _	Nord-Sud	Est-Ouest	SIMULTANÉ DU ROY RENÉ						
	NS	EO													
1															
2															
3															
4															
5															
6															
7															
8															
9									<b>Entame :</b>	<b>Sud</b>	<b>Ouest</b>	<b>Nord</b>	<b>Est</b>		
10								 7			—	—	1 		
11								<b>Par :</b>							
12									Ouest 1SA +1		1 	—	—		
13								Séance n°5		1 SA	—	—			
14										—	—	—			
15										—	—	—			
													www.bridgeplus.com - Simultanés Roy René		